

Data Sheet



Article number: 021816011306

Description: Clamp with bracket and rubber
SPGU 6011. 306/30 SK

Measures

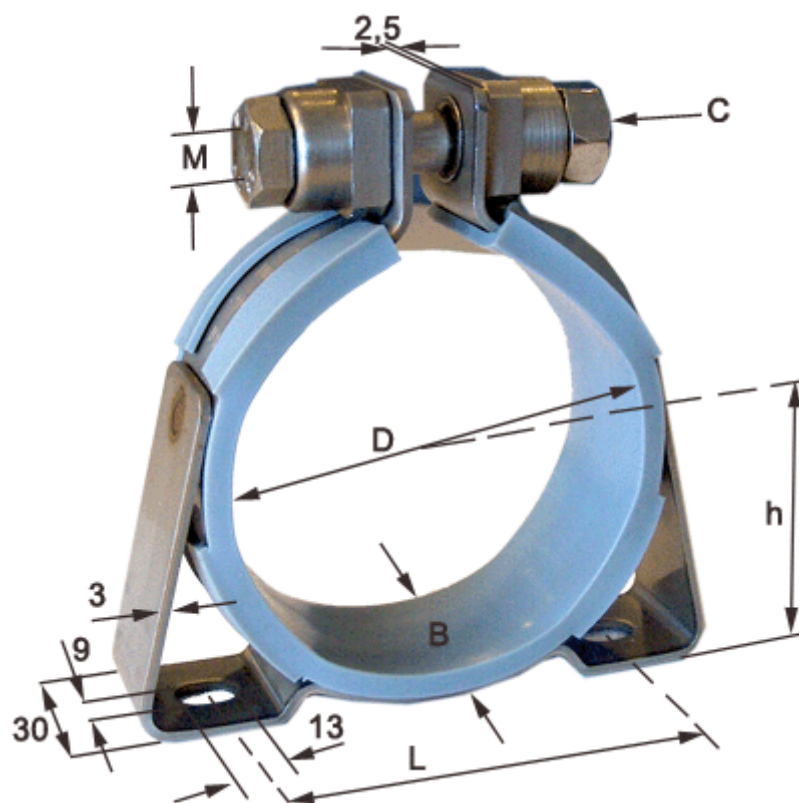

C (screw type) = SK hexagon screw

Diameter D = 306

h = 161

L = 280

Width B = 30